

CONTADORES DE CICLOS

PM-CVPL

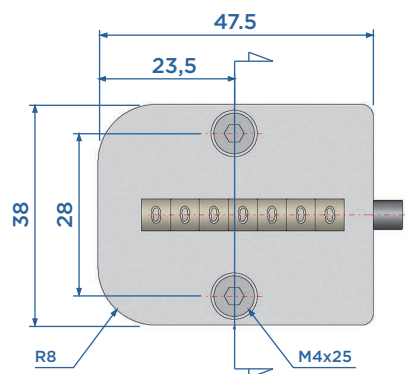

LINHA DE CORTE AA

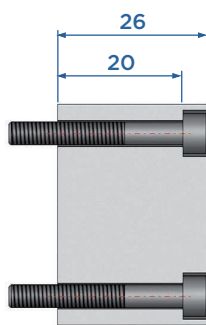

CORTE AA

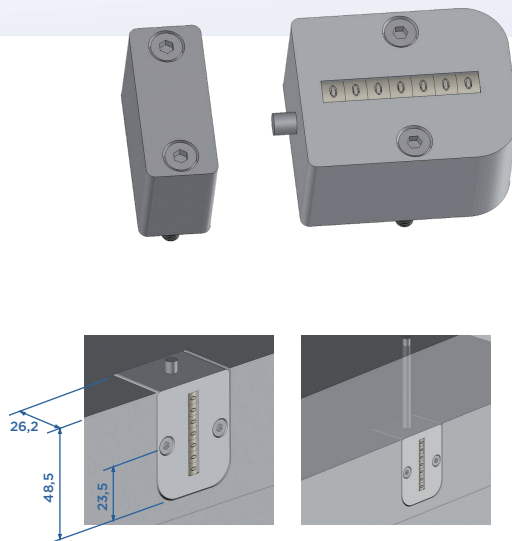

PM-CVR

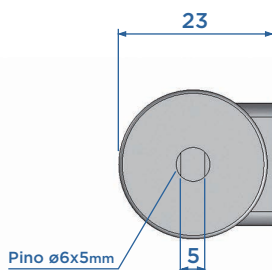
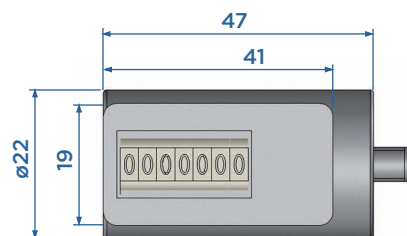

Pino ø6x5mm

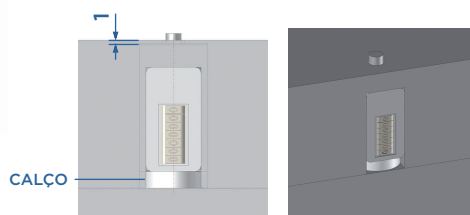

CALÇO

CCHS5328

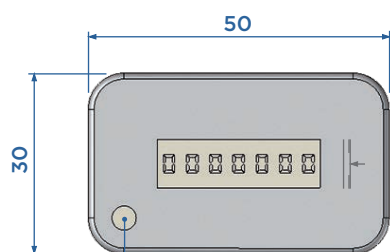
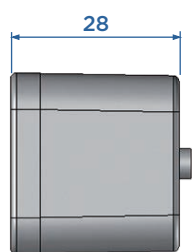

RESET

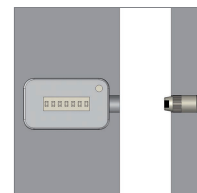
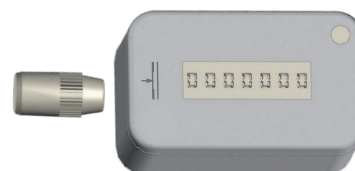
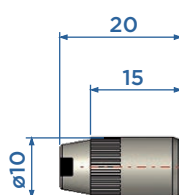

Código	Descrição
PM-CVPL	Contador de Ciclos - Mecânico Quadrado
PM-CVEX	Contador de Ciclos - Mecânico Externo
PM-CVR	Contador de Ciclos - Mecânico Redondo
CCHS5328	Contador de Ciclos - Eletrônico Quadrado (CUMSA)