

# BASE MONOBLOCO - PBM

Material: INOX  
Dureza: 51 ± 3 HRC

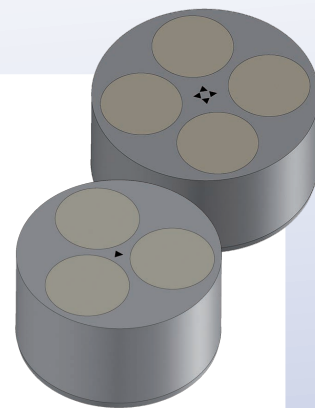

Código	A	C	E	#PPM
PBM160603	16	6.5	16	12
PBM180604	18	6.5	18	14
PBM220903	22	8.7	22	16
PBM250904	25	8.7	18	12
PBM281103	28	11.5	22	14
PBM321104	32	11.5	26	16

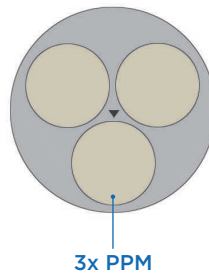
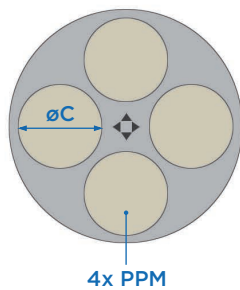
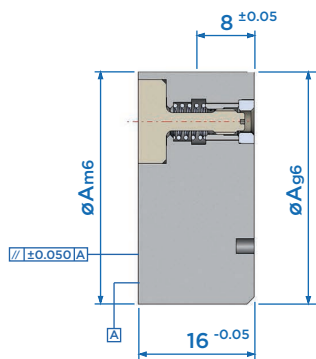
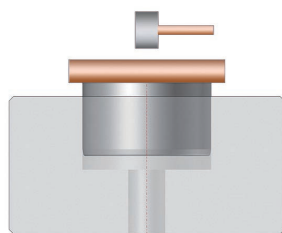
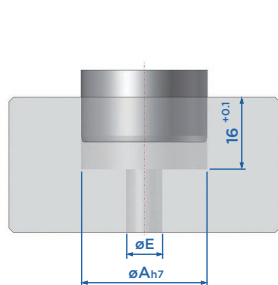

Aplicação

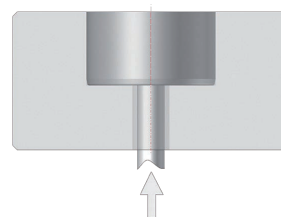

# INSERTO MONOBLOCO - PPM

Material: INOX  
Dureza: 51 ± 3 HRC

Forma de pedido: PPM0615-XX - Ex. PPM0615-07  
ATENÇÃO: Verificar diâmetro "C" da Base Monobloco

INSERTOS DE RECICLAGEM			

MARCADORES					

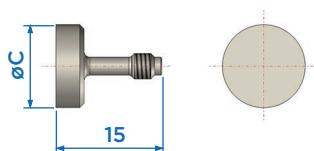

Código	C
PPM0615-...	6.5
PPM0915-...	8.7
PPM1115-...	11.5

